

# *OpenEye*<sup>®</sup>

## **MA - SERIES CLOUD MANAGED APPLIANCE**

OPERATIONS MANUAL



*OpenEye*<sup>®</sup> | THERE'S MORE TO BE SEEN

OpenEye MA-Series Recorders  
Hardware Manual

Manual Edition 35452AE – July 2018

©2018, OPENEYE  
All Rights Reserved

No part of this document may be reproduced by any means, electronic or mechanical, for any purpose, except as expressed in the Software License Agreement. OPENEYE shall not be liable for technical or editorial errors or omissions contained herein. The information in this document is subject to change without notice.

The information in this publication is provided “as is” without warranty of any kind. The entire risk arising out of the use of this information remains with recipient. In no event shall OPENEYE be liable for any direct, consequential, incidental, special, punitive, or other damages whatsoever (including without limitation, damages for loss of business profits, business interruption or loss of business information), even if OPENEYE has been advised of the possibility of such damages or whether in an action, contract or tort, including negligence.

This software and documentation are copyrighted. All other rights, including ownership of the software, are reserved to OPENEYE. Heroic Customer Service, OpenEye Web Services, ME-Series, and Apex Server are registered trademarks of OPENEYE in the United States and elsewhere; Windows is a registered trademarks of Microsoft Corporation. All other brand and product names are trademarks or registered trademarks of the respective owners.

The following words and symbols mark special messages throughout this guide:



**Note** Text set off in this manner indicates information that is necessary for proper operation of the product.

OPENEYE  
Liberty Lake, WA • U.S.A.

---

## IMPORTANT SAFEGUARDS

---

1. **Read Owner's Manual** – After unpacking this product, read the owner's manual carefully, and follow all the operating and other instructions.
2. **Power Sources** – This product should be operated only from the type of power source indicated on the label. If not sure of the type of power supply to your home or business, consult product dealer or local power company.
3. **Ventilation** – Slots and openings in the cabinet are provided for ventilation and to ensure reliable operation of the product and to protect it from overheating, and these openings must not be blocked or covered. The product should not be placed in a built-in installation such as a bookcase or rack unless proper ventilation is provided or OpenEye's instructions have been adhered to.
4. **Heat** – The product should be situated away from heat sources such as radiators, heat registers, stoves, or other products that produce heat.
5. **Water and Moisture** – Do not use this product near water. Do not exceed the humidity specifications for the product as detailed in the Appendix section in this manual.
6. **Cleaning** – Unplug this product from the wall outlet before cleaning. Do not use liquid cleaners or aerosol cleaners. Use a damp cloth for cleaning.
7. **Power Cord Protection** – Power-supply cords should not be routed so that they are likely to be walked on or pinched by items placed against them, paying particular attention to cords at plugs, receptacles, and the point where they exit the product.
8. **Overloading** – Do not overload wall outlets; extension cords, or integral convenience receptacles as this can result in a risk of fire or electrical shock.
9. **Object and Liquid Entry Points** – Never insert foreign objects into the recorder, other than the media types approved by OpenEye, as they may touch dangerous voltage points or short-out parts that could result in a fire or electrical shock. Never spill liquid of any kind on the product.
10. **Accessories** – Do not place this product on an unstable cart, stand, tripod, bracket, or table. The product may fall, causing serious personal injury and serious damage to the product.
11. **Disc Tray** – Keep fingers well clear of the disc tray as it is closing. Neglecting to do so may cause serious personal injury.
12. **Burden** – Do not place a heavy object on or step on the product. The object may fall, causing serious personal injury and serious damage to the product.
13. **Disc** – Do not use a cracked, deformed, or repaired disc. These discs are easily broken and may cause serious personal injury and product malfunction.
14. **Replaceable Batteries** – CAUTION: Risk of Explosion if Battery is replaced by an Incorrect Type. Dispose of Used Batteries According to the Instructions.
15. **Grounded Outlet** – This equipment shall be connected to a properly grounded outlet.
16. **Outlet Location** – This equipment must be installed within six feet of an easily accessible outlet.
17. **Damage Requiring Service** – Unplug the unit from the outlet and refer servicing to qualified service personnel under the following conditions:
  - When the power-supply cord or plug is damaged.
  - If liquid has been spilled, or objects have fallen into the unit.
  - If the unit has been exposed to rain or water.
  - If the unit does not operate normally by following the operating instructions. Adjust only those controls that are covered by the operating instructions as an improper adjustment of other controls may result in damage and will often require extensive work by a qualified technician to restore the unit to its normal operation

- If the unit has been dropped or the enclosure has been damaged.
  - When the unit exhibits a distinct change in performance - this indicates a need for service.
18. **Servicing** – Do not attempt to service this product unless instructed to by an OpenEye engineer. Opening or removing covers may expose the user to dangerous voltage or other hazards. Refer all servicing to qualified personnel.
  19. **Replacement Parts** – When replacement parts are required, be sure the service technician has used replacement parts specified by OpenEye or have the same characteristics as the original part. Unauthorized substitutions may result in fire, electric shock or other hazards.
  20. **Safety Check** – Upon completion of any service or repairs to this unit, ask the service technician to perform safety checks to determine that the unit is in proper operating condition.

---

## NOTES ON HANDLING

---

Please retain the original shipping carton and/or packing materials supplied with this product. To ensure the integrity of this product when shipping or moving, repackage the unit as it was originally received from OpenEye.

Do not use volatile liquids, such as aerosol spray, near this product. Do not leave rubber or plastic objects in contact with this product for long periods of time. They will leave marks on the finish.

The top and rear panels of the unit may become warm after long periods of use. This is not a malfunction.

---

## NOTES ON LOCATING

---

Place the unit on a level surface. Do not use it on a shaky or unstable surface such as a wobbling table or inclined stand.

If this unit is placed next to a TV, radio, or VCR, the playback picture may become poor and the sound may be distorted. If this happens, place the recorder away from the TV, radio, or VCR.

---

## NOTES ON CLEANING

---

Use a soft dry cloth for cleaning.

For stubborn dirt, soak the cloth in a weak detergent solution, wring well and wipe. Use a dry cloth to wipe it dry. Do not use any type of solvent, such as thinner and benzene, as they may damage the surface of the recorder.

If using a chemical saturated cloth to clean the unit, follow that product's instructions.

---

## NOTES ON MAINTENANCE

---

This recorder is designed to last for long periods of time. To keep the recorder always operational we recommend regular inspection maintenance (cleaning parts or replacement). For details contact the nearest dealer.

---

## NOTES ON MOISTURE CONDENSATION

---

Moisture condensation could damage the recorder. Read the following information carefully.

Moisture condensation might occur under the following circumstances:

- When this product is brought directly from a cool location to a warm location.
- When this product is moved to a hot and humid location from a cool location.
- When this product is moved to a cool and humid location from a warm location.
- When this product is used in a room where the temperature fluctuates.
- When this product is used near an air-conditioning unit vent.
- When this product is used in a humid place.

**Do not use the recorder when moisture condensation may occur.**

If the recorder is used in such a situation, it may damage discs and internal parts. Remove any CD discs, connect the power cord of the recorder to the wall outlet, turn on the recorder, and leave it for two to three hours. After two to three hours, the recorder will warm up and evaporate any moisture. Keep the recorder connected to the wall outlet and moisture will seldom occur.

---

## WARNING

---

TO REDUCE THE RISK OF ELECTRICAL SHOCK, DO NOT EXPOSE THIS APPLIANCE TO RAIN OR MOISTURE.

DANGEROUS HIGH VOLTAGES ARE PRESENT INSIDE THE ENCLOSURE.

DO NOT OPEN THE CABINET.

REFER SERVICING TO QUALIFIED PERSONNEL ONLY.

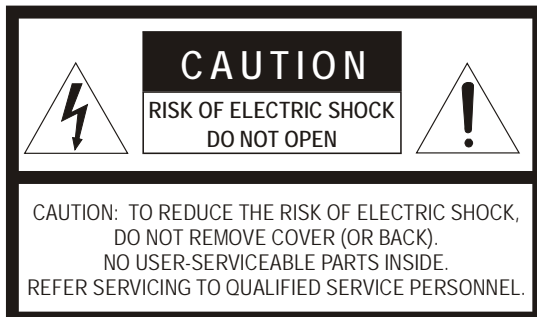

---

## EXPLANATION OF GRAPHICAL SYMBOLS

---

The lightning flash with arrowhead symbol, within an equilateral triangle, is intended to alert the user to the presence of un-insulated "dangerous voltage" within the product enclosure that may be of sufficient magnitude to constitute a risk of electric shock to persons.



---

## FCC STATEMENT

---

This equipment has been tested and found to comply with the limits for a Class A digital device, pursuant to Part 15 of the FCC Rules. These limits are designed to provide reasonable protection against harmful interference when the equipment is operated in a commercial environment. This equipment generates, uses, and can radiate radio frequency energy and, if not installed and used in accordance with the instruction manual, may cause harmful interference to radio communications. Operation of this equipment in a residential area is likely to cause harmful interference in which case the user will be required to correct the interference at their own expense.

---

## Standard Warranty

---

OpenEye warrants all new products to be free from defects in workmanship and material under normal use **for a period of three years** after the date of purchase. Any defective product that falls under this warranty will, at OpenEye's discretion, be repaired or replaced at no additional charge. OpenEye may elect to replace defective products with new or factory reconditioned products of equal or greater value. Repairs made necessary by reason of misuse, alteration, normal wear, or accident are not covered under this warranty.

Exceptions to this are listed below:

- Three Years on all Digital Recorders
- Three years on all analog fixed cameras

All products shall be covered by a one year advance replacement warranty\*.

OpenEye will warrant all otherwise out of warranty replacement parts and repairs for 90 days from the date of OpenEye shipment.

The above warranty is the sole warranty made by OpenEye and is in lieu of all other warranties by OpenEye express and implied, including without limitation the warranties of merchantability and fitness for a particular purpose. Under no circumstances will OpenEye be liable for any consequential, incidental, special or exemplary damages arising out of or connected with the sale, delivery, use or performance of the product, even if OpenEye is apprised of the likelihood of such damages occurring. In no event shall OpenEye liability exceed the purchase price of the product.

This warranty gives you specific legal rights and you may also have other rights which vary from state to state or country to country.

*\*Requires corresponding security deposit. Advanced Replacement limited to components only outside of the USA and Canada.*

28574AG

For the most up to date information visit [www.openeye.net](http://www.openeye.net).

# TABLE OF CONTENTS

Table of Contents .....	7
<b>Introduction .....</b>	<b>8</b>
Product Description .....	8
Features.....	9
Controls and Connections .....	10
MA-Series Front Panel.....	10
MA-Series Rear Panel (8 Channel) .....	10
MA-Series Rear Panel (16 Channel) .....	10
Getting Started .....	11
Box Contents.....	11
Keyboard Setup.....	12
Mouse Setup .....	12
Monitor Setup.....	13
Connecting analog Cameras to the BNC Inputs .....	13
Connecting an IP Camera to the MA-Series Recorder .....	13
Sensor / Relay Card.....	14
Setting Up the Recorder for the First Time .....	15
<b>Operating Your Recorder .....</b>	<b>16</b>
Turning On the Recorder.....	16
Turning Off the Recorder.....	16
Reimaging Your Apex Server Recorder .....	16
<b>Specifications .....</b>	<b>17</b>

# INTRODUCTION

## PRODUCT DESCRIPTION

---



The OpenEye MA Hybrid NVR model is a cloud managed appliance designed for hassle free, plug-n-play installation.

MA model recorders come equipped to support both HD analog and IP video up to 24 channels and come preloaded with OpenEye's powerful Apex recording software.

To learn more about the MA model recorder or the rest of OpenEye's M-Series recorder lineup visit [www.openeye.net](http://www.openeye.net).



## FEATURES

---

OpenEye Apex Server MA-Series recorders include the following features:

- Fully integrated with OpenEye Web Services (OWS)
- Hybrid chipset supports both HD analog and IP video up to 24 channels
- Supports HD-TVI/AHD/CVBS analog cameras
- H264+ smart codec support
- Solid State OS drive for improved reliability and fast boot times
- Complete remote operation and administration with Web Connect
- Up to 20TB on-board storage
- Online User Management via OWS
- Cloud video export and sharing
- Cloud-based health monitoring and reporting with real time alerts
- Remote software updates with no need to be on-site
- Advanced cyber security including multi-factor authentication for remote access
- Dual network ports allow use of an isolated camera network for added reliability and security
- Mobile apps available for Android and iOS

# CONTROLS AND CONNECTIONS

## MA-SERIES FRONT PANEL



## MA-SERIES REAR PANEL (8 CHANNEL)

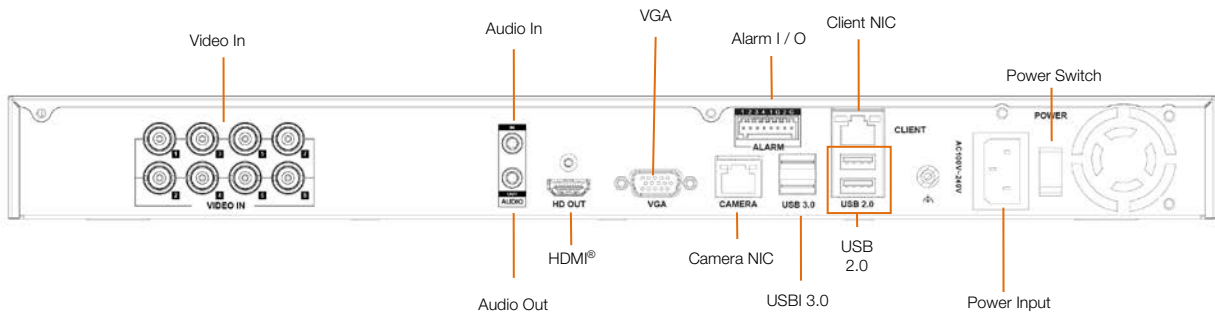

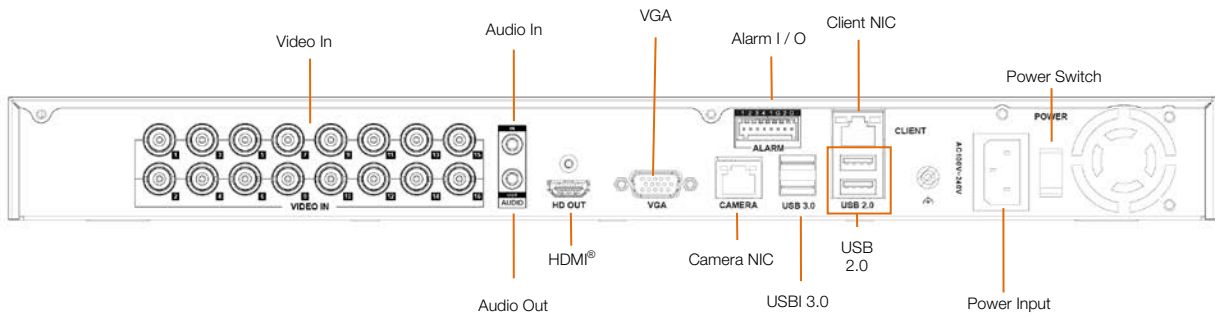

## MA-SERIES REAR PANEL (16 CHANNEL)



## GETTING STARTED

### BOX CONTENTS

OpenEye OE-MA Apex recorders come with a power cord, keyboard, mouse, and a recovery USB. A QuickStart guide and other necessary documentation are also included. Identify the following components to make sure everything has been properly included with your new recorder. If any of the following items are missing, contact the dealer to arrange a replacement.

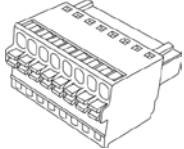
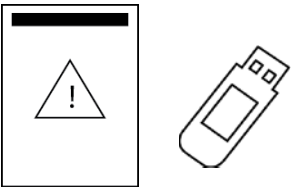
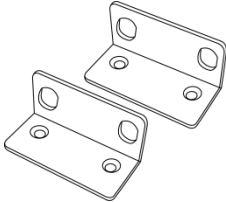
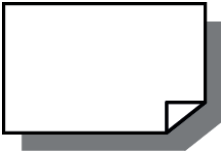
 <p>OE-MA Apex Recorder</p>	 <p>Power Cord</p>
 <p>Keyboard and Mouse</p>	 <p>Alarm I / O Block</p>
 <p>Recovery Instructions and Recovery USB</p>	 <p>Rack Mount Installation Kit</p>
 <p>QuickStart Guide</p>	

## KEYBOARD SETUP

To attach the keyboard, connect the keyboard to a USB port located on the back of the recorder.

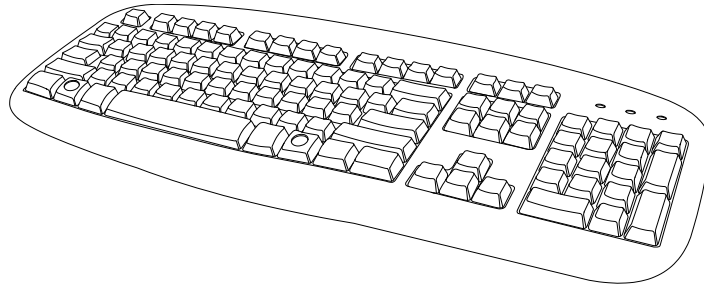

## MOUSE SETUP

To attach the mouse to your recorder, connect the mouse to a USB port located on the back of the machine.

In this manual:

**Click** means to position the mouse cursor over an item and to single click the left button.

**Right click** means to position the mouse cursor over an item and to single click the right button.

**Double-click** means to position the mouse cursor over an item and to click the left button twice.

**Select** means to position the mouse cursor over a radio button, checkbox, or list item and click on it.

The scroll wheel in between the two buttons is used for added navigation functionality. By moving the wheel with index finger (scrolling), quickly move through multiple pages, lines, or windows. The wheel may also function as a third button allowing the user to quickly click or double-click an icon or a selected item.

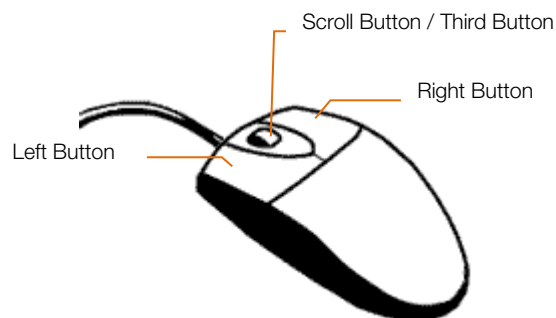

## MONITOR SETUP

These connections are available to connect a monitor:

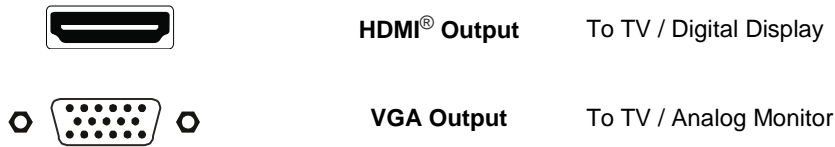

Attach the monitor(s) to the rear of the recorder using the cable supplied by the monitor manufacturer. Refer to the monitor manual for detailed information on how to setup and use it.



**Note** The monitor must be capable of a minimum screen resolution of 1024x768 and support 32 bit color.



**Note** Maximum VGA Resolution: 1920 x 1080/60Hz  
Maximum HDMI® Resolution: 3840 x 2160/30Hz

## CONNECTING ANALOG CAMERAS TO THE BNC INPUTS

The back of the recorder contains up to 16 video inputs depending on the model. The connectors use the BNC standard.

Plug one end of the video source (HD-TVI, AHD, CVBS Camera) into the desired BNC input.

## CONNECTING AN IP CAMERA TO THE MA-SERIES RECORDER

**Automatic:** Apex Server software automatically detects ONVIF Profile S compliant IP cameras set to DHCP. Cameras not meeting these requirements must be configured manually.

1. Click **Setup**, and then click **Cameras**.
2. Click **Add Cameras**.
3. For automatically detected cameras, select the camera(s) using the check boxes, and then type the appropriate **Username** and **Password**.
4. Click **Add**.

**Manual:** Apex Server software automatically detects ONVIF Profile S compliant IP cameras set to DHCP. Cameras not meeting these requirements must be configured manually.

1. Click **Setup**, and then click **Cameras**.
2. Click **Add Cameras**.
3. For cameras not automatically detected, click **Add Cameras Manually**.
4. Select the ONVIF or the RTSP protocol, and then type the appropriate **Title**, **IP Address**, **Username**, and **Password**.

# SENSOR / RELAY CARD

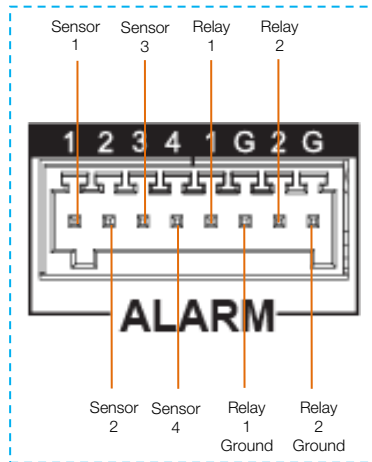
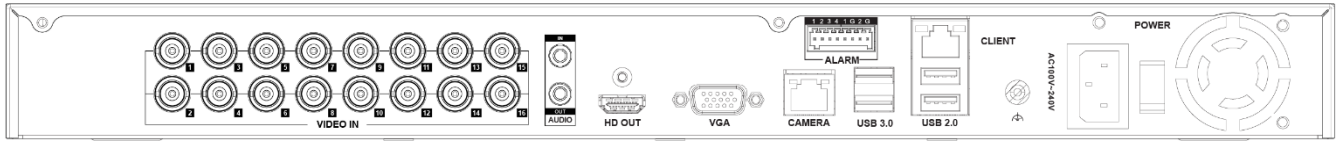

## SETTING UP THE RECORDER FOR THE FIRST TIME

---

1. Plug the supplied power cord into the recorder. **Do not connect the plug to a power source at this time.**
2. Connect the network cable intended for remote connections to the Client NIC.



**Note** The Camera NIC is intended for use with a dedicated camera network. The Client NIC is intended for use to access the internet and provide remote client connections.

3. Plug the supplied power cord into the recorder. **Do not connect the plug to a power source at this time.**
4. Connect the network cable intended for any dedicated camera networks to the Camera NIC.
5. Connect the supplied **keyboard** and **mouse** using the USB ports.
6. Connect a **monitor** using the HDMI® or VGA port.
7. Connect the analog **cameras** to the BNC Video Inputs.
8. Connect the **power cord** to a power source, and then turn the recorder ON.
9. Log in to the Apex Server recorder using the default credentials:  
**Username:** admin  
**Password:** 1234
10. Follow the **Setup Wizard** to complete basic setup of your system.

# OPERATING YOUR RECORDER

## TURNING ON THE RECORDER

---

1. Turn on the monitor connected to your recorder.
1. Use the power switch on the rear of the recorder to turn the recorder **On**.
2. The recorder will run a series of self-tests. If asked to respond to any messages, follow the instructions carefully.

Startup is complete when the Apex Server software is finished loading and displays the main login screen.

## TURNING OFF THE RECORDER

---

1. Click **Setup**, and then click **Power Off / Restart**.
2. Click **Power Off**.

## REIMAGING YOUR APEX SERVER RECORDER

---

1. Insert the **Recovery USB** drive into an available USB port, and then restart the recorder. For faster completion, it is recommended to insert the USB drive into a USB 3.0 port.
2. If the USB does not auto boot into the Recovery menu, then restart the NVR and immediately press the F12 key on the keyboard until the Boot Device Menu appears on the screen.
3. Select the **UEFI: USB "device name"** option, and then press **Enter**.
4. When the **System Recovery** window appears, click **Continue**, and then click **Ok**.
5. Choose the re-image option. **The Conditional Re-image** will erase the OS and all settings, but retain video data. **The Complete Re-image** will erase all settings and data on the primary drive.
6. Type the **unit serial number** found on the back or side of the unit.
7. Accept the warning message, and then click **Continue**.
8. Upon successful completion, click **Finish**, and then remove the USB drive.



**Note** It is very important to remove the USB drive after the re-imaging process is complete, otherwise the NVR may not boot properly.

**Note** Call OpenEye Support at 888-542-1103, option #2, for more information regarding the re-imaging process.



# SPECIFICATIONS

	OE-MAX08	OE-MAX16
<b>RECORDING</b>		
Max Total Channels	24 (Analog + IP)	
Built-In Analog Channels	8	16
Max IP Recording Resolution	4k (8mp)	
Max Analog Recording Resolution	HD-TVI (2MP) / AHD (2MP) / CVBS (960h)	
Max Recording Rate	100Mbps	
Image Compression	H264+	
Audio Support	IP Camera Audio (dependent on camera)	
<b>CONNECTIONS</b>		
Video Outputs	1 x HDMI® / 1 x VGA	
Max Display Resolution	4K (HDMI®) / 1080p (VGA)	
Network Port 1	Dedicated Intel®GbE for Client Network	
Network Port 2	Dedicated Intel®GbE for Camera Network	
Alarm Sensor Inputs	4 x Form A contacts	
Digital Relay Outputs	2 x Form A contacts	
USB Ports	Front: 2 x USB 2.0 Rear: 2 x USB 2.0 / 2 x USB 3.0	
<b>SOFTWARE</b>		
Operating System	Linux	
Video Signal Loss Detection	Yes	
Motion Detection	Server Side (Adjustable Sensitivity, Custom Grid)	
Remote Operation	Command Station (desktop VMS client) / Thin (web) Client / Mobile Apps	
User Management	Local or web based user permissions and account management	
Recording Mode	Continuous / Motion / Continuous + Motion	
Playback Search	Multi-channel playback / Calendar / Timeline / Thumbnail	
Clip Backup	Cloud / USB	
Digital Signature Support	Yes	
Web Connect	Yes	
<b>GENERAL</b>		
Keyboard and Mouse	Included	
Internal Power Supply	290W (100V-240V Auto Switching)	
Max Power Consumption	195W	
Operating Temperature	Max Temperature: 104°F (40 °C)	
<b>RECORDER</b>		
OS Drive Configuration	Dedicated Solid State Drive	
Max Storage Configuration	20TB	
Processor	Intel® Celeron	
Dimensions	W: 17.25 x H: 1.75 x D: 13.5in (438 x 44 x 343mm)	
Unit Weight	20lbs (9.07kg)	
Rack Mount	Installation Kit Included	
Regulatory	UL	
Warranty	3 Years, 1 year advanced replacement	

[www.openeye.net](http://www.openeye.net)

509-232-5261

© 2018 OpenEye

All rights reserved. No part of this publication may be reproduced by any means without written permission from OpenEye. The information in this publication is believed to be accurate in all respects. However, OpenEye cannot assume responsibility for any consequences resulting from the use thereof. The information contained herein is subject to change without notice. Revisions or new editions to this publication may be issued to incorporate such changes.