

CONNECTIONS

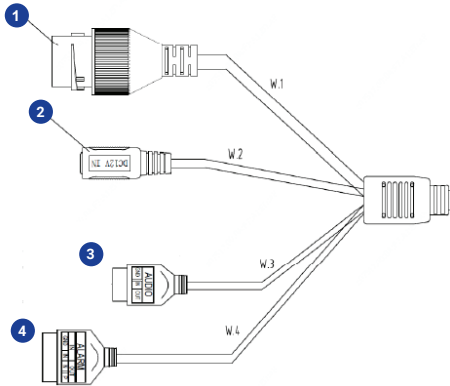

1	RJ-45	For network and PoE connections
2	Power (12VDC)*	Power connection
3	Audio I/O	Ground
		Audio In Audio Out
4	Alarm I/O	Ground
		Alarm In
		Alarm Out -
		Alarm Out +

*12VDC power input port should be plugged when not in use.

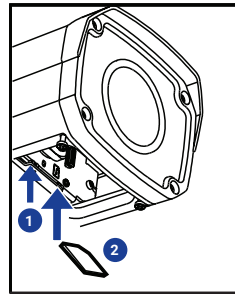
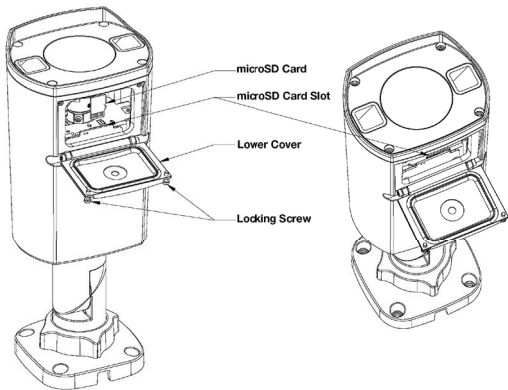

1	Reset Jumper	To restore the camera to factory defaults: 1. Disconnect power for 30 seconds. 2. Reconnect power and wait 30 seconds. 3. Close the jumper connection with a proper tool for 20 seconds.
2	microSD Card Slot	Supports up to 512GB microSD card for Edge storage. Do not add or remove the microSD card when the camera is powered on.

Waterproof Cable

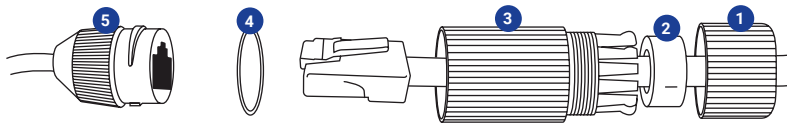

1	Thread lock cap	4	Rubber "O" ring
2	Rubber plug	5	Camera cable
3	RJ45 enclosure		

OpenEye

The Cloud Video Platform

Liberty Lake, WA, USA
509.232.5261

openeye.net

Copyright ©2021 OpenEye.

All Rights Reserved. Information contained in this document is subject to change without prior notice. OpenEye does its best to provide accurate information but cannot be held responsible for typos or mistakes.

This quick start guide provides only basic information on the camera's settings and operation for initial installation. Please read the user manual for optimal camera configurations.

OpenEye
The Cloud Video Platform

QUICK START GUIDE

OE-C2012B4
4MP | Outdoor | IP Bullet

37555AB

openeye.net

CONTENTS

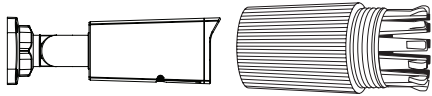

OE-C2012B4
Bullet Camera

Waterproof Cable
Connector



Self-Tapping
Screws &
Plastic Anchors



Mounting Template

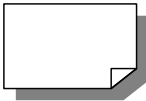

Quick Start
Guide

INSTALLATION

1. Apply template sticker to desired camera location.
2. Drill anchor holes using included mounting template.
3. Remove mounting template.
4. Insert anchors.
5. Mount camera.
6. Connect network cable with included waterproof cable connector.
7. Adjust camera view.

POWER

This camera is compatible with 12vDC and Power over Ethernet (PoE). If you are connecting 12vDC power, verify the polarity of the power connection.

ETHERNET CABLE CONNECTIONS

Connect a network cable to the camera using the RJ45 input and connect the other end of the cable to your network switch or recorder.

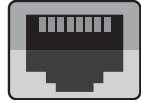

DEFAULT USERNAME AND PASSWORD

NOTE: OpenEye IP cameras ship without a default password.

The admin user password can be set using the following methods:

1. OpenEye recorders running Apex 2.1 or newer will automatically set a new unique password if:
 - Connected to an M-Series recorder with a built in PoE switch.
 - Connected to a network switch through the camera network port and selected then added in setup, if a new password has not already been set.
2. Connect to the camera directly through a Web Browser and follow the onscreen prompts.
3. Use the Network Camera Manager (NCM) Utility.

Username: **admin**

NOTE: The NCM software manual can be found at <https://www.openeye.net/ncm-manual>



NOTE: Refer to your Apex recorder manual or quick start guide for instruction on adding cameras. Passwords must be 9-32 characters including at least two elements of the following three: digits, letters, and special characters.

ASSIGNING AN IP ADDRESS

OpenEye IP cameras are set to DHCP by default. If a DHCP server is not detected after 4 minutes, the camera will default to IP address 192.168.51.2. If you are not using a DHCP server, NCM will allow you to batch configure a static IP address.

The IP address for the camera network on your Apex recorder is 192.168.51.1.



NOTE: To change this IP address please refer to your Apex recorder manual.

Selecting multiple cameras and entering IP address 192.168.51.2 will set an IP address on all selected cameras, starting at 192.168.51.2 and increase per camera.

1. Open the Network Camera Manager application.
2. Select applicable camera(s).
3. Input starting IP address, Subnet Mask, Gateway, DNS.
4. Apply changes.
5. Wait 60 seconds before refreshing NCM.

CONNECTING TO THE IP CAMERA

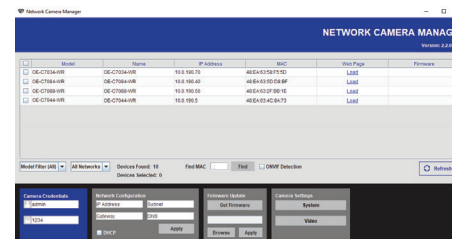

To access the camera setup menu, you need to open Network Camera Manager (NCM) utility. NCM is pre-installed on all OpenEye Recorders, and is also available for download on the OpenEye website for installation on your personal computer or laptop.

1. Open Network Camera Manager.
2. Locate your camera on the Network Camera Manager list.
3. To open the web browser, select the camera and click LOAD.

PRODUCT FEATURES

Camera	
Maximum Resolution	2688x1520
Frame Rate at Maximum Resolution	30FPS @ 4MP H.264/H.265
Total Streams	Dual Streaming
ONVIF	Profile S / G / T Compliant
Day/Night	True Day / Night
Wide Dynamic Range	True WDR

Environmental and Power	
Power Consumption	9.5W Max
Input Voltage	12vDC / PoE
Operating Temperature	-22°~140°F (-30°~60°C)
IP Rating	IP67